

KEITHLEY

Model 6105 Resistivity Adapter Instruction Manual

Contains Operating and Servicing Information

**Publication Date: October 1972
Document Number: 31415**

WARRANTY

Keithley Instruments, Inc. warrants this product to be free from defects in material and workmanship for a period of 1 year from date of shipment.

Keithley Instruments, Inc. warrants the following items for 90 days from the date of shipment: probes, cables, rechargeable batteries, diskettes, and documentation.

During the warranty period, we will, at our option, either repair or replace any product that proves to be defective.

To exercise this warranty, write or call your local Keithley representative, or contact Keithley headquarters in Cleveland, Ohio. You will be given prompt assistance and return instructions. Send the product, transportation prepaid, to the indicated service facility. Repairs will be made and the product returned, transportation prepaid. Repaired or replaced products are warranted for the balance of the original warranty period, or at least 90 days.

LIMITATION OF WARRANTY

This warranty does not apply to defects resulting from product modification without Keithley's express written consent, or misuse of any product or part. This warranty also does not apply to fuses, software, non-rechargeable batteries, damage from battery leakage, or problems arising from normal wear or failure to follow instructions.

THIS WARRANTY IS IN LIEU OF ALL OTHER WARRANTIES, EXPRESSED OR IMPLIED, INCLUDING ANY IMPLIED WARRANTY OF MERCHANTABILITY OR FITNESS FOR A PARTICULAR USE. THE REMEDIES PROVIDED HEREIN ARE BUYER'S SOLE AND EXCLUSIVE REMEDIES.

NEITHER KEITHLEY INSTRUMENTS, INC. NOR ANY OF ITS EMPLOYEES SHALL BE LIABLE FOR ANY DIRECT, INDIRECT, SPECIAL, INCIDENTAL OR CONSEQUENTIAL DAMAGES ARISING OUT OF THE USE OF ITS INSTRUMENTS AND SOFTWARE EVEN IF KEITHLEY INSTRUMENTS, INC., HAS BEEN ADVISED IN ADVANCE OF THE POSSIBILITY OF SUCH DAMAGES. SUCH EXCLUDED DAMAGES SHALL INCLUDE, BUT ARE NOT LIMITED TO: COSTS OF REMOVAL AND INSTALLATION, LOSSES SUSTAINED AS THE RESULT OF INJURY TO ANY PERSON, OR DAMAGE TO PROPERTY.



Test Instrumentation Group, Keithley Instruments, Inc. • 28775 Aurora Road • Cleveland, Ohio 44139 • (216) 248-0400 • Fax: (216) 248-6168

CHINA: Keithley Instruments, Inc. • Holiday Inn Lido • Office Building 404C • Beijing, China, 100004 • 8610-436-2871/2860 • 8610-436-2871

FRANCE: Keithley Instruments SARL • 3 Allée des Garays • B.P. 60 • 91122 Palaiseau Cédex • 01-60-11-51-55 • Fax: 01-60-11-77-26

GERMANY: Keithley Instruments GmbH • Landsberger Str. 65 • 82110 Germering • 089-849307-0 • Fax: 089-84930759

GREAT BRITAIN: Keithley Instruments, Ltd. • The Minster • 58 Portman Road • Reading, Berkshire RG30 1EA • 01734-575666 • Fax: 01734-596469

ITALY: Keithley Instruments SRL • Viale S. Gimignano 38 • 20146 Milano • 02-48303008 • Fax: 02-48302274

JAPAN: Keithley Instruments Far East KK • Sumiyoshi 24 Bldg., Room 201 • 2-24-2 Sumiyoshi-cho • Naka-ku, Yokohama 231 • 81-45-201-2246 • Fax: 81-45-201-2247

NETHERLANDS: Keithley Instruments BV • Avelingen West 49 • 4202 MS Gorinchem • Postbus 559 • 4200 AN Gorinchem • 01830-35333 • Fax: 01830-30821

SWITZERLAND: Keithley Instruments SA • Kricsbachstrasse 4 • 8600 Dübendorf • 01-821-9444 • Fax: 01-820-3081

SECTION 1. GENERAL INFORMATION

1-1. GENERAL.

a. The Model 6105 Resistivity Adapter is a guarded test fixture for measuring volume and surface resistivities of materials when used with a regulated power supply and an electrometer. The complete system permits measurement of volume resistivity from 10^3 to 3×10^{19} ohm-cm and surface resistivity from 10^3 to 5×10^{18} ohms, in accordance with procedures of the American Society for Testing and Materials. The Adapter can accommodate samples up to 4 inches in diameter and 1/4 inch thick with excitation voltages up to 1000 volts.

b. The Model 6105 has been designed to minimize measurement error. The electrode configurations conform to the ASTM recommendations for measurement of electrical resistance of insulating materials. The test sample is shielded to prevent stray pickup. The guard ring circuit is arranged to minimize leakage currents from the measuring circuit. Uniform pressure is always applied over the measuring area, because the test sample is held between the spring-loaded, guarded electrode and the one-pound test weight assembly. Due to these considerations, measurement accuracy depends primarily upon the accuracy of the voltage source and the electrometer.

c. Recommended instruments for use with the Model 6105 are the Keithley Model 240A Regulated High Voltage Supply and the Keithley Model 610C Multi-Range Electrometer. The Model 240A provides excitation voltages up to 1200 volts in calibrated one-volt steps. Its output is accurate within 1%. The Model 610C provides direct reading current ranges to 10^{-14} ampere full scale. Its accuracy is $\pm 2\%$ of full scale to 10^{-11} ampere, and $\pm 4\%$ of full scale beyond. Although the Model 240A and the Model 610C are the recommended instruments for use with the Resistivity Adapter, the Model 6105 is compatible with all Keithley high voltage supplies and electrometers.

1-2. SPECIFICATIONS.

SAMPLE SIZE: Maximum: 4-inch diameter (10.2-cm diameter)
Minimum: 2-1/2-inch diameter (6.3-cm diameter)

SAMPLE THICKNESS: 1/16 inch to 1/4 inch (0.159 cm to 0.635 cm).

TEST VOLTAGE RANGE: 1 volt to 1000 volts.
MAXIMUM TEST VOLTAGE: 1000 volts.

VOLUME RESISTIVITY RANGES: 1.5×10^2 to 1.5×10^{18} ohm-inches (10^3 to 10^{19} ohm-cm).

SURFACE RESISTIVITY RANGES: 10^3 to 10^{18} ohms.

CONNECTORS: Power: Teflon insulated uhf-type receptacle.
Electrometer: BNC-type receptacle.

DIMENSIONS: 6 inches wide x 4-1/2 inches deep x 4 inches high.

NET WEIGHT: 3 pounds.

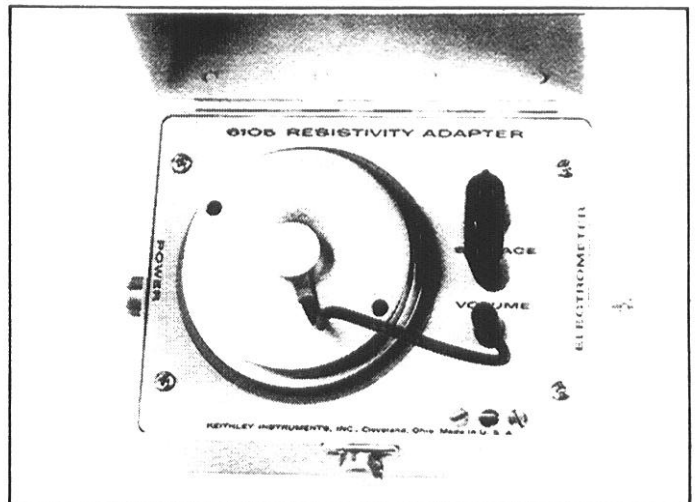

FIGURE 1. MODEL 6105

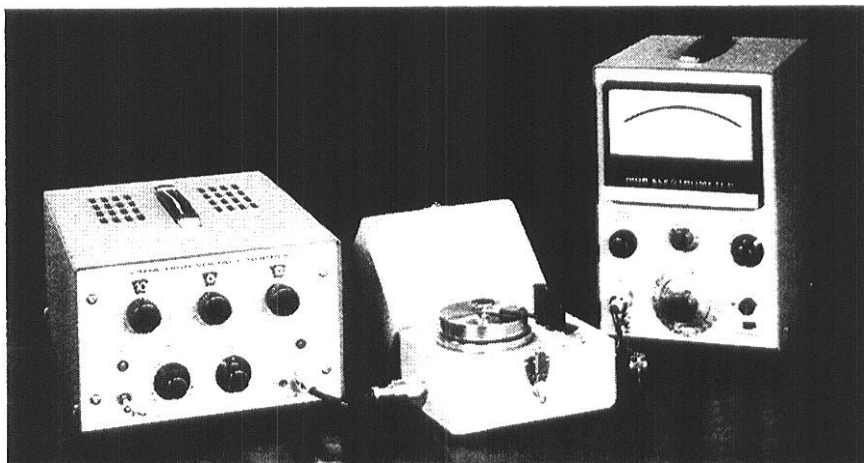

FIGURE 2. RESISTIVITY MEASURING SYSTEM

SECTION 2. OPERATION

2-1. **PREPARATION FOR USE.** The Model 6105 is shipped with two thumb-screw fasteners holding the test weight to the guard ring. Remove these fasteners and store for later use. These are used only for shipping and they should not be used during measurements. In mounting the sample for measurement, make sure there are no conductive paths between the electrodes other than those through the sample. The sample should be supported from the electrodes so that the electrodes do not touch anything except the sample. Do not handle the sample with bare fingers; acetate rayon gloves are recommended. For best results, clean the sample surfaces with an alcohol and ether mixture or other suitable solvent.

a. Volume Resistivity Measurements. Place the short circuit plug over the upper two jacks, leaving "VOLUME" clearly visible. Insert the banana plug from the test weight assembly into the bottom jack. Close the Model 6105 cover. An interlock switch disconnects the potential to the sample if the cover is opened. Apply the power supply voltage. Read the current on the electrometer. The value of the volume resistivity ρ , is found through one of the following calculations:

$$\rho = \frac{3.53 V}{t_i I} \text{ ohm-inches}$$

$$\rho = \frac{22.9 V}{t_c I} \text{ ohm-centimeters}$$

where ρ is the volume resistivity of the sample;
 V is the applied voltage from the power supply in volts;
 t_i is the average thickness of the sample in inches;
 t_c is the average thickness of the sample in centimeters;
 I is the current reading from the electrometer.

b. Surface Resistivity Measurements. Place the short circuit plug over the lower two jacks, leaving "SURFACE" clearly visible. Insert the banana plug from the test weight assembly into the top jack. Close the Model 6105 cover. Apply the power supply voltage. Read the current on the electrometer. The value of the surface resistivity is found through the following calculation:

$$\sigma = \frac{53.4 V}{I} \text{ ohms}$$

where σ is the surface resistivity of the sample;
 V is the applied voltage from the power supply in volts;
 I is the current reading from the electrometer.

2-2. **CONNECTIONS.** Connect the power supply to the uhf-type receptacle. Connect the electrometer to the bnc-type receptacle. Place the sample under the test weight as shown in Figure 5. The sample thickness should be between 1/16 and 1/4 inch (0.159 and 0.635 cm). The diameter should be between 2-1/2 and 4 inches (6.29 and 10.2 cm).

2-3. **PROCEDURE.** The Model 6105 permits easy measurement of a sample. The test sample is placed between the two electrodes; the desired test potential is selected from the voltage supply and the current passing through the test sample is measured by the electrometer. From readings from the voltage supply and the electrometer, the resistivities can be computed.

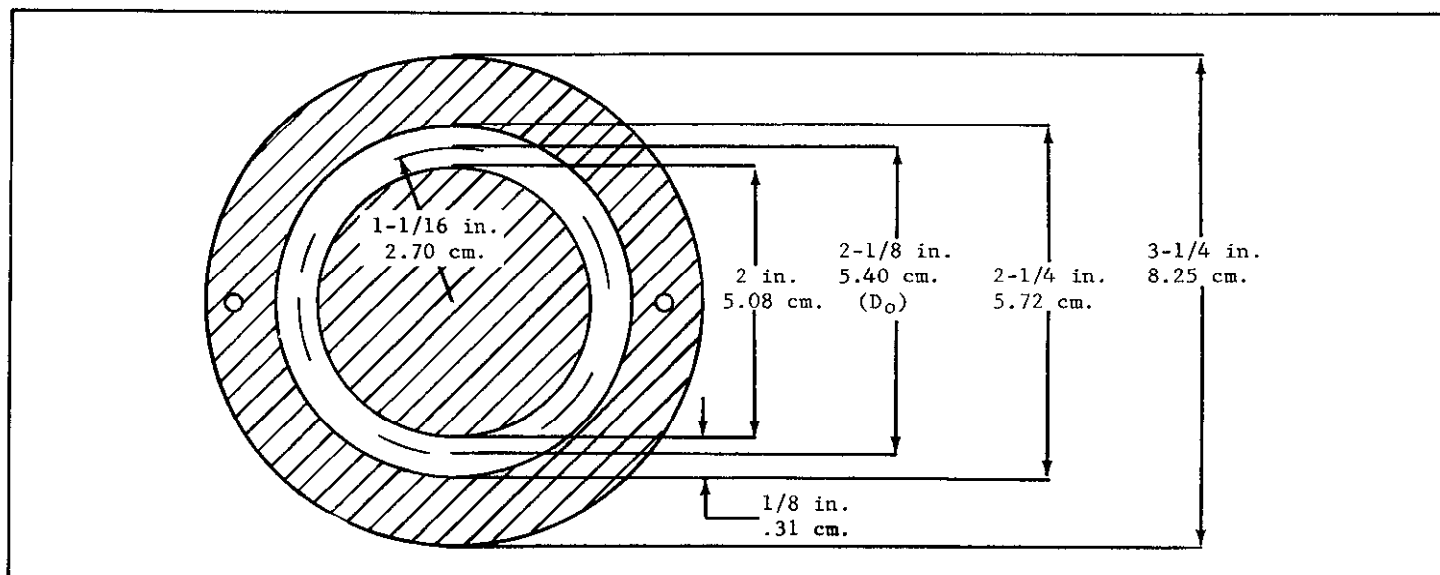
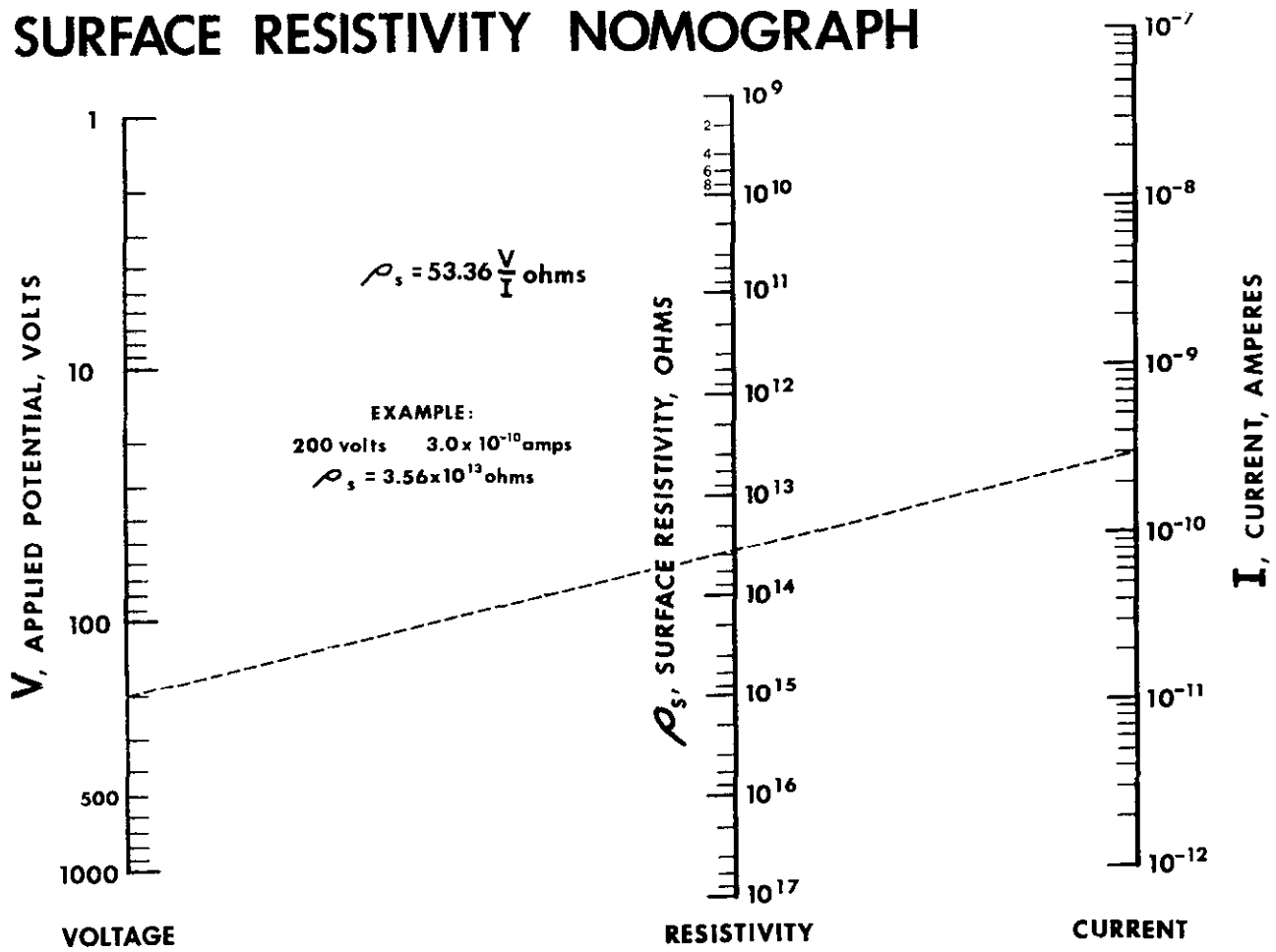
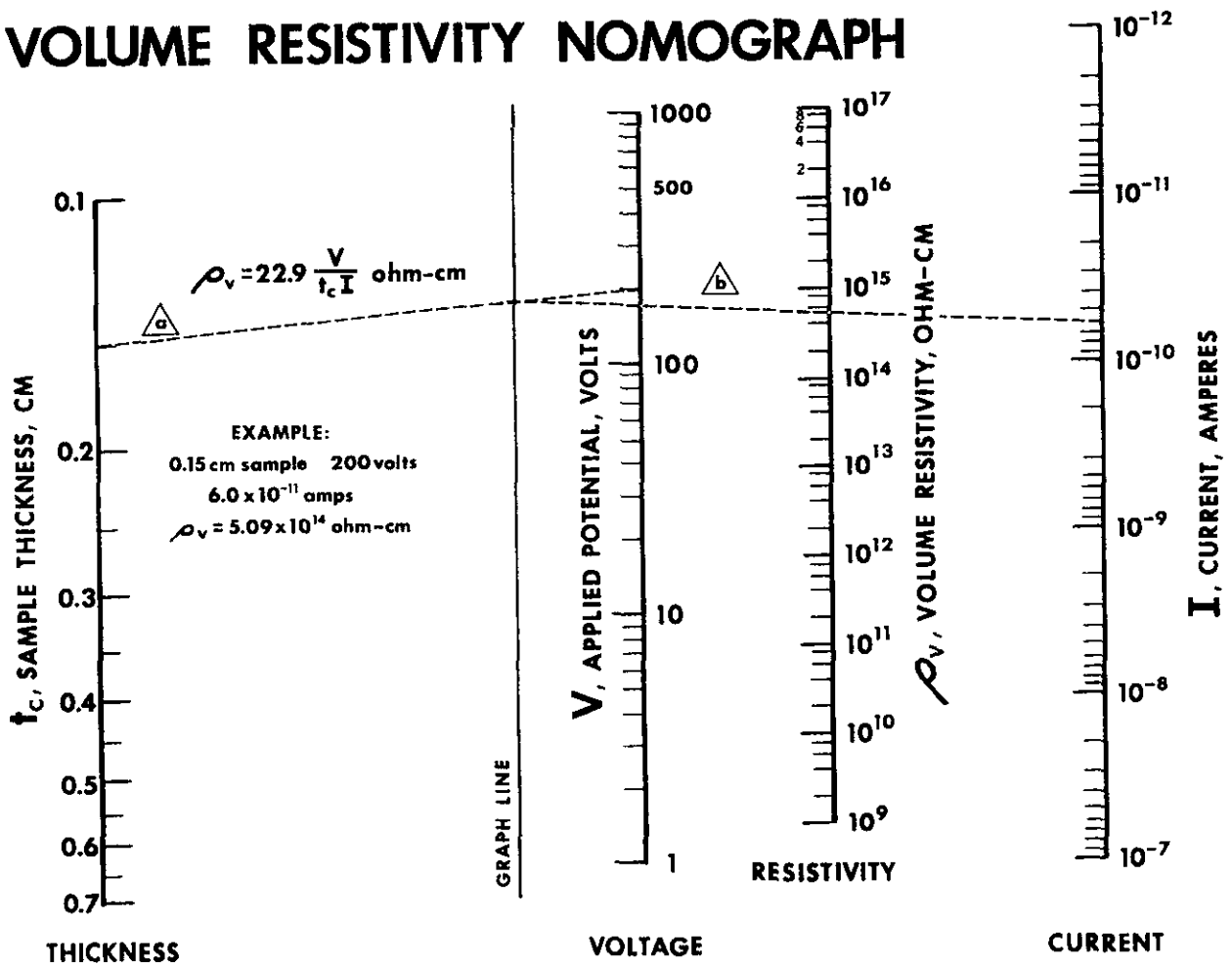

FIGURE 3. DIMENSIONING FOR MODEL 6105 ELECTRODES

SURFACE RESISTIVITY NOMOGRAPH



VOLUME RESISTIVITY NOMOGRAPH



SECTION 3. THEORY OF OPERATION

3-1. VOLUME RESISTIVITY. The ASTM Standard* states that volume resistivity, ρ , shall be calculated as follows:

$$\rho = \frac{A}{t} R$$

where R is the volume resistance, in ohms, measured as specified in the publication;
 t is the average thickness of the sample;
 A is the effective area of the guarded electrode for the particular electrode arrangement employed.

For the Model 6105, which uses circular electrodes, A is

$$A = \frac{D_o^2}{4} \pi$$

where D_o is the dimension indicated in Figure 3. For the Model 6105, D_o is equal to 2-1/8 inches or 5.40 cm.

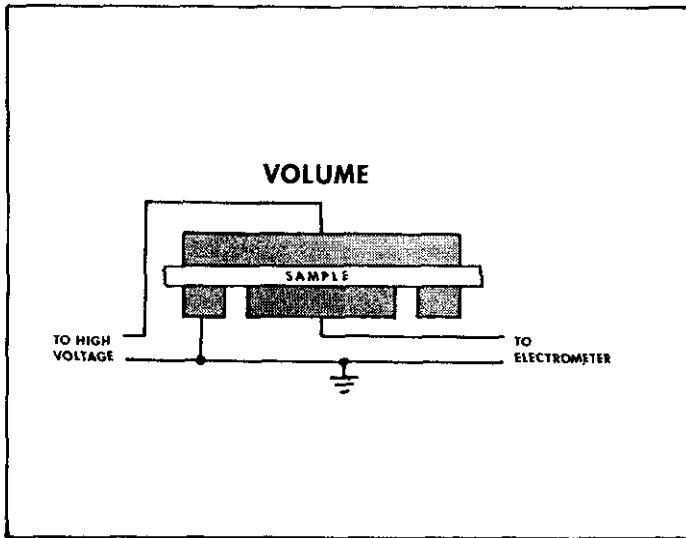

FIGURE 4. VOLUME RESISTIVITY

3-2. SURFACE RESISTIVITY. The ASTM Standard* states that surface resistivity, σ , shall be calculated as follows:

$$\sigma = \frac{P}{g} R$$

where R is the surface resistance, in ohms, measured as specified in the publication;
 g is the distance between the electrodes;
 P is the effective perimeter of the guarded electrode for the particular electrode arrangement employed.

For the Model 6105, which uses circular electrodes, P, is

$$P = D_o \pi$$

where D_o is the dimension indicated in Figure 3.

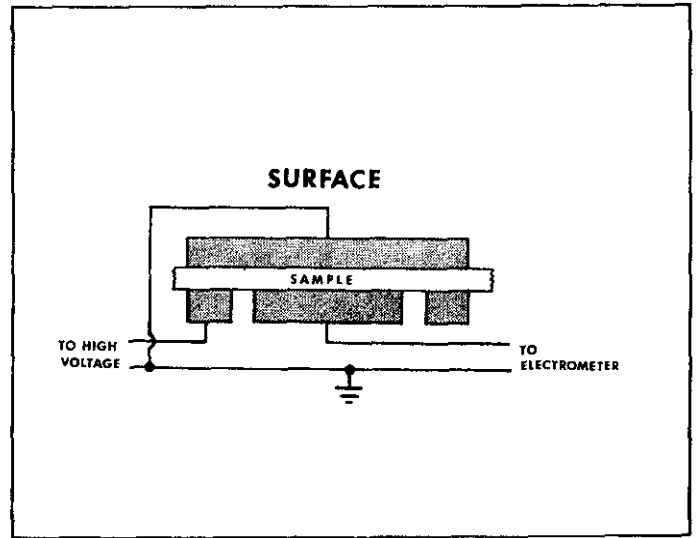
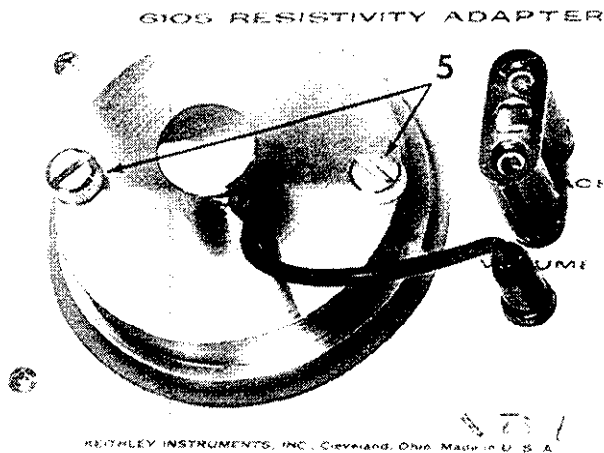
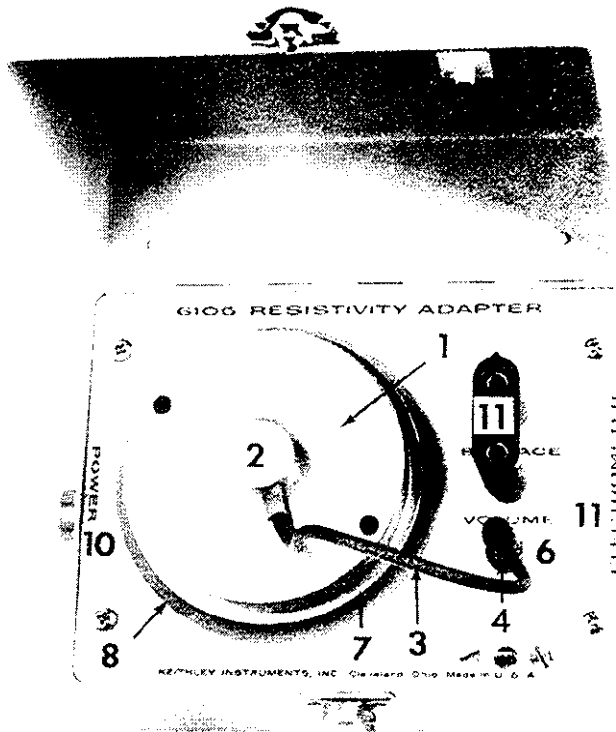

FIGURE 5. SURFACE RESISTIVITY

*American Society for Testing and Materials, Standard Methods of Test for Electrical Resistance of Insulating Materials, ASTM Designation D257-66

SECTION 4. MAINTENANCE

4-1. MAINTENANCE. The electrodes of the Model 6105 should be periodically cleaned with an alcohol and ether mixture or other suitable solvent. The connectors should also be kept clean to prevent leakage when the electrometer is making a measurement. The electrodes should also be kept smooth.



PARTS LIST

Item	Description	Mfr. Desig.	Mfr. Code	Keithley Part No.
-	Resistivity Adapter	-	80164	Model 6105
-	. Test Weight Assembly	-	80164	15702A
1	. . Test Weight, Stainless Steel	-	80164	16371A
2	. . Handle Assembly	-	80164	16231A
3	. . Test Lead Assembly	-	80164	15706B
4	. . . Banana Plug	108-303	74970	BG-5
5	. Fastener, Thumb-Screw	-	80164	SMC-4
6	. Banana Jack (3 reqd.)	108-903	74970	BJ-6
7	. Guard Ring	-	80164	16370A
8	. Guard Ring Insulator	-	80164	15708A
-	. Test Plate Assembly	-	80164	15709B
-	. . Test Plate	-	80164	16369A
9	. Receptacle, bnc	31-221	02660	CS-15
-	(Mate of bnc receptacle)	31-002	02660	CS-44
10	. Receptacle, uhf, Mil. No. SO-239	6804	91737	CS-64
-	(Mate of uhf receptacle, Mil. No. 49190)	5127	91737	CS-49
11	Modified Short Circuit Plug	-	80164	23443A

KEITHLEY

Test Instrumentation Group

Keithley Instruments, Inc.

28775 Aurora Road

Cleveland, Ohio 44139

Printed in the U.S.A.